



*Positive Energy*



ESAN  
AKU

2005

First and Founding Member of AKÜDER



2008

Pioneer in Technological Transformation:  
Production of Sealed Maintenance Free Battery

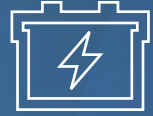

1998

Modern Production Facilities:  
Ayazağa/Şişli



1985

Branding Proceeds with Esan, Energy, Vega and Pure Energy



1978

Establishment:  
Maslak / İstanbul



1997

Esan Battery Stepped Into Global Markets:  
First Export Agreement



1998

Second Generation in Charge



2006

Quality Management Systems: ISO 9001, ISO 14001 ve ISO 45001

## Sustainable Excellence

- 44 Years of Experience
- Export to More Than 65 Countries in 4 Continents
- More Than 200 Dealership Network at Internal Market and Abroad

**2010**  
We Are Growing: Establishment of Esan Battery and Materials Industry & Trade Inc.



2010

**1MILYON**

**2011**  
Exmet Investment: 1,2 M  
Production Capacity

**2014**  
Technological Investments:  
Line Automation Robot Usage And  
New Battery Charging Systems



**2016**

We Are in Our New Production Facility!  
20.000 SQM in Gebze Organized Industrial Zone.  
Use of the Latest Technologies.  
Production Capacity: 2,5 M Pcs / Year



**ISO**

**2015**  
Quality Management Systems:  
ISO 10002



**2018**  
R&D Center  
Approved by the  
Ministry of Industry and Technology

**2020**  
Start - Stop EFB Battery  
Serial Production



2020



**2019**  
Esan Plastic:  
Container and Lid  
Manufacturing Plant



**2021**  
Esan Metal

### Star of the Industry

- Turkish Exporters Assembly 1000
  - ISO 1000
  - Esan Plastic
  - Esan Metal
  - R&D Center
  - IATF: 16949
  - Turquality





**RUSSIA**

**AFGHANISTAN**

**MONGOLIA**

**CHINA**

**NORTH KOREA**

**JAPAN**

**SOUTH KOREA**

**AFGHANISTAN**

**KASHMIR**

**PAKISTAN**

**NEPAL**

**BHUTAN**

**BANGLADESH**

**INDIA**

**MYANMAR (BURMA)**

**LAOS**

**THAILAND**

**CAMBODIA**

**VIETNAM**

**SRI LANKA**



**RESPECT NATURE**

FOR FUTURE GENERATIONS

Esan Battery acts with the principle of respect for nature in all activities and this principle is taken into account in all decisions. Training and awareness-raising activities are organized in order to create this awareness in employees and other related parties.



**POSITIVE ENERGY  
CARES ABOUT  
NATURE**

**Charge level indicator  
integrated on lid**

**Terminal cover design  
compatible with  
the new battery**

**Ergonomic battery  
handle design**

**Ca-Ca  
technology**

**Negative plate with  
PE envelope**





*Positive Energy*



**Special alloy for high strength terminal**

**Special alloy for intercell connections**

**High corrosion resistant positive plate with strengthened formula**

# EUROPEAN TYPE BATTERIES



High cranking and cycle capacity



Special internal structure and high performance



High corrosion resistance and low water loss



High cycle and vibration performance



Maintenance Free SMF Technology



## Lid Types

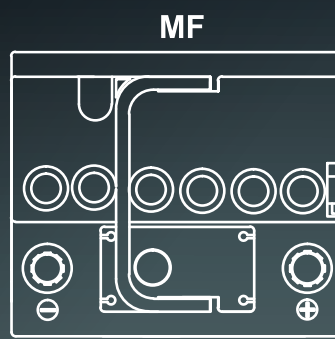
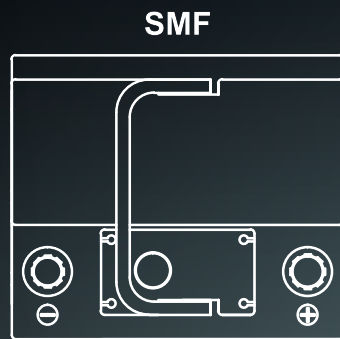

## Terminal Types

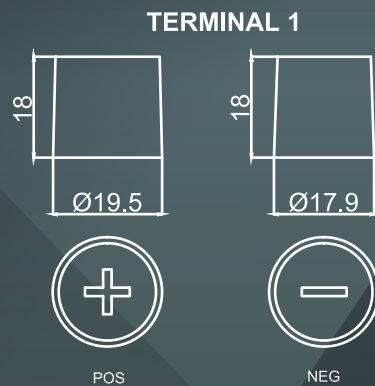

## Layout Types

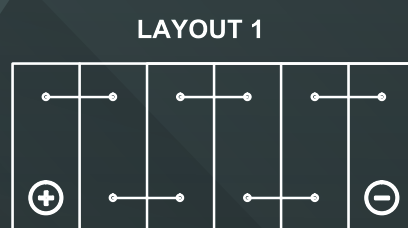
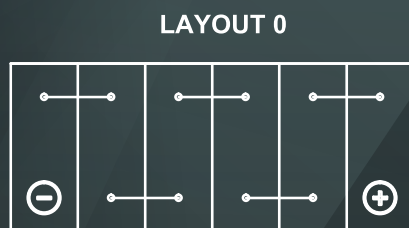

## Hold-down Types

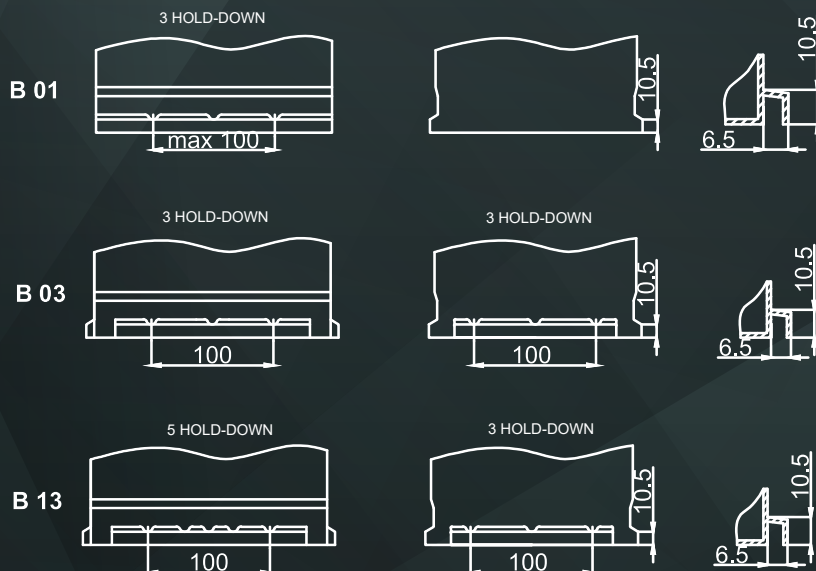

## Product Code Description

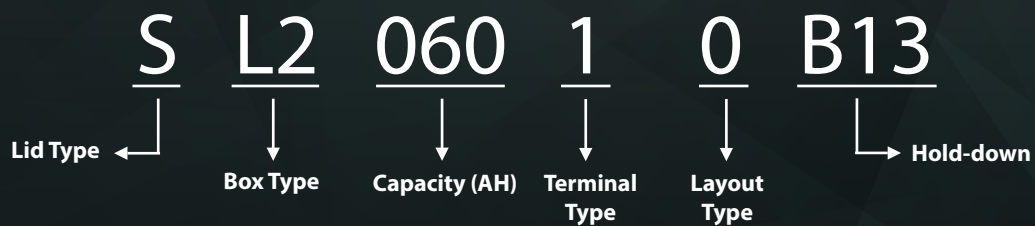

## EUROPEAN TYPE BATTERIES

Box Type	Product Number		Capacity Ah/20h	CCA		Terminal Type	Layout Type	Hold-down
	MF	SMF		EN	DIN			
LB1	LB1 044 10B13	S LB1 044 10B13	44	360	220	1	0/1	B13
	LB1 045 10B13	S LB1 045 10B13	45	360	220	1	0/1	B13
	LB1 050 10B13	S LB1 050 10B13	50	420	230	1	0/1	B13
L1	L1 044 10B13	S L1 044 10B13	44	360	220	1	0/1	B13
	L1 045 10B13	S L1 045 10B13	45	360	220	1	0/1	B13
	L1 050 10B13	S L1 050 10B13	50	420	230	1	0/1	B13
LB2	LB2 050 10B13	S LB2 050 10B13	50	420	230	1	0/1	B13
	LB2 055 10B13	S LB2 055 10B13	55	460	240	1	0/1	B13
	LB2 060 10B13	S LB2 060 10B13	60	540	255	1	0/1	B13
	LB2 062 10B13	S LB2 062 10B13	62	550	290	1	0/1	B13
L2	L2 050 10B13	S L2 050 10B13	50	420	230	1	0/1	B13
	L2 055 10B13	S L2 055 10B13	55	460	240	1	0/1	B13
	L2 060 10B13	S L2 060 10B13	60	540	255	1	0/1	B13
	L2 062 10B13	S L2 062 10B13	62	550	290	1	0/1	B13

## AREAS OF USAGE

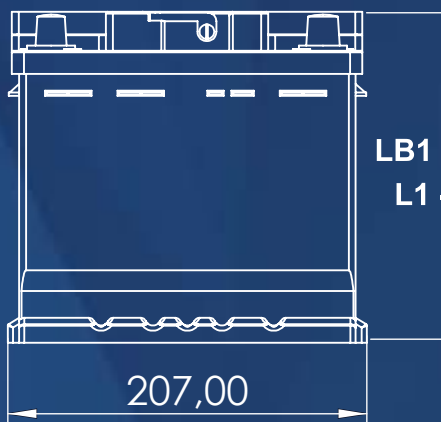

LB1 - 175  
L1 - 190

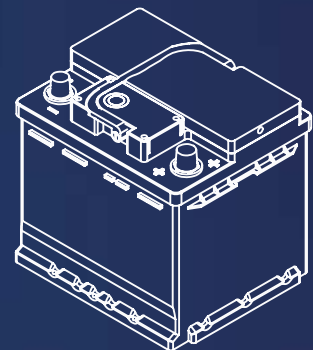
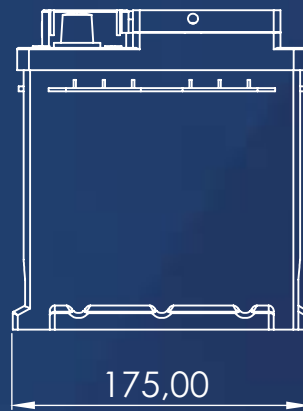

LB2-175  
L2-190

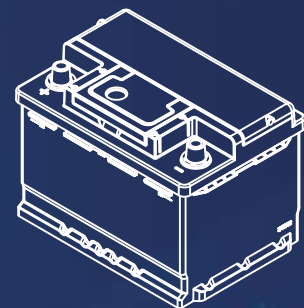
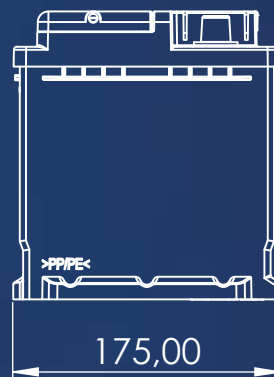

# EUROPEAN TYPE BATTERIES

Box Type	Product Number		Capacity Ah/20h	CCA		Terminal Type	Layout Type	Hold-down
	MF	SMF		EN	DIN			
LB3	LB3 066 10B13	S LB3 066 10B13	66	590	300	1	0/1	B13
	LB3 072 10B13	S LB3 072 10B13	72	640	360	1	0/1	B13
	LB3 074 10B13	S LB3 074 10B13	74	650	380	1	0/1	B13
	LB3 075 10B13	S LB3 075 10B13	75	650	380	1	0/1	B13
L3	L3 066 10B01	S L3 066 10B01	66	590	300	1	0/1	B01
	L3 072 10B01	S L3 072 10B01	72	640	360	1	0/1	B01
	L3 074 10B01	S L3 074 10B01	74	650	380	1	0/1	B01
	L3 075 10B01	S L3 075 10B01	75	650	380	1	0/1	B01
LB4	LB4 080 10B13	S LB4 080 10B13	80	700	410	1	0/1	B13
L4	L4 080 10B13	S L4 080 10B13	80	700	410	1	0/1	B13
LB5	LB5 088 10B13	S LB5 088 10B13	88	720	420	1	0/1	B13
	LB5 100 10B13	S LB5 100 10B13	100	800	480	1	0/1	B13
L5	L5 088 10B13	S L5 088 10B13	88	720	420	1	0/1	B13
	L5 100 10B13	S L5 100 10B13	100	800	480	1	0/1	B13



TURKEY'S  
SECOND TOP 500 INDUSTRIAL  
ENTERPRISES  
2020

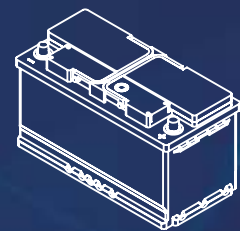
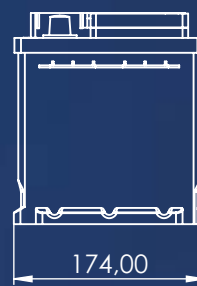
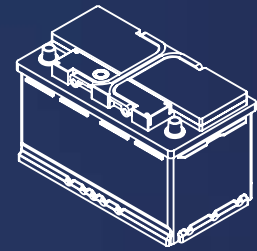
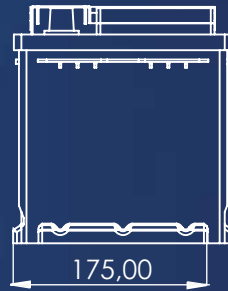
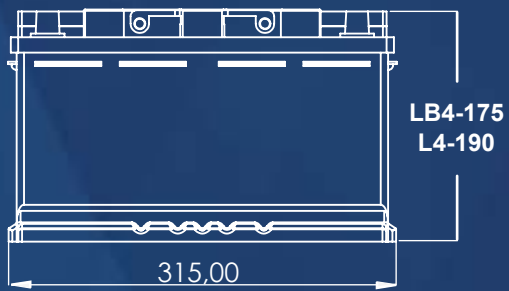
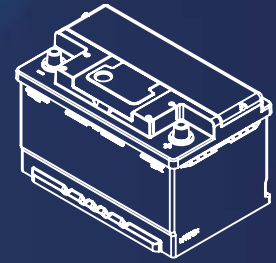
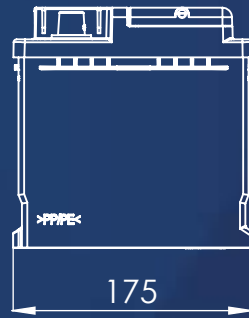
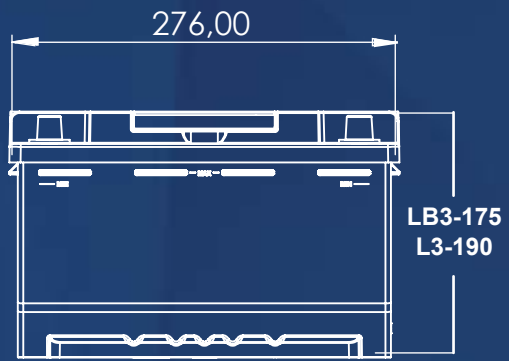

# EUROPEAN TYPE BATTERIES

Box Type	Product Number	Capacity Ah/20h	CCA		Terminal Type	Layout Type	Hold-down
	MF		EN	DIN			
H4	H4 105 10B03	105	760	440	1	0/1	B03
	H4 110 10B03	110	780	460	1	0/1	B03
D2a	D2 110 10B01	110	780	460	1	0	B01
D3a	D3 128 10B01	128	860	500	1	0	B01

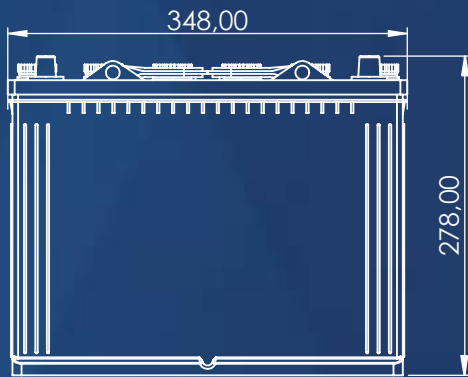
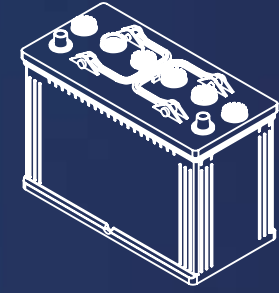
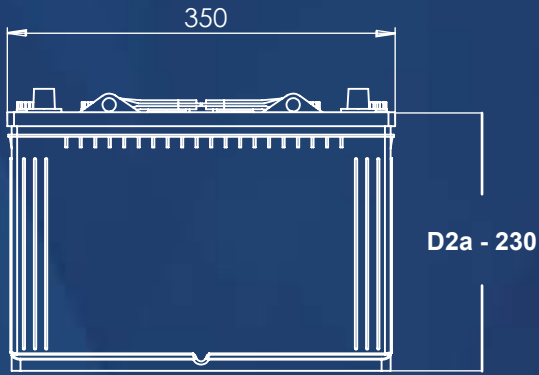
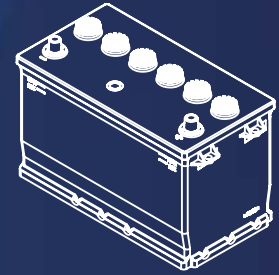
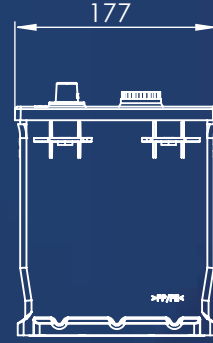
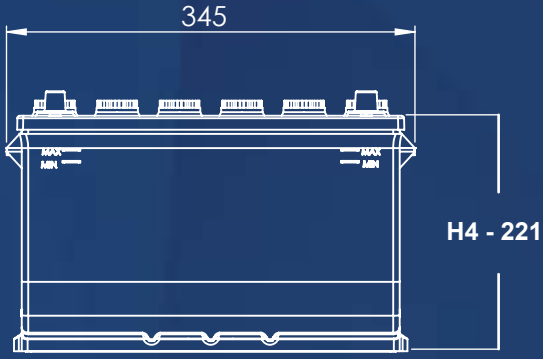

# ASIAN TYPE BATTERIES



High cranking and cycle capacity



Special internal structure and high performance



High corrosion resistance and low water loss



High cycle and vibration performance



Maintenance Free SMF Technology

The **WORLD**  
Gets  
its **Power**  
from **US!**



## Lid Types

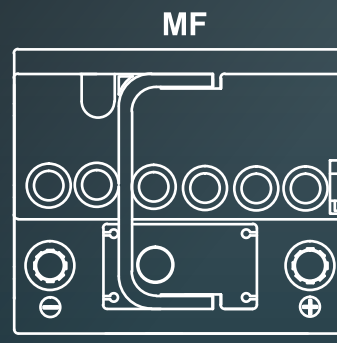
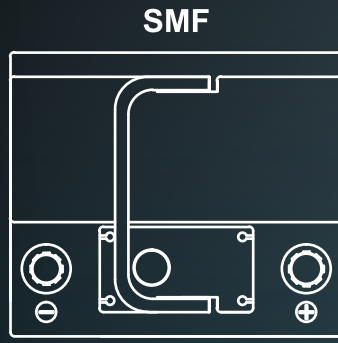

## Terminal Types

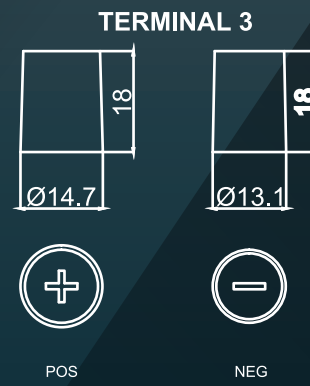
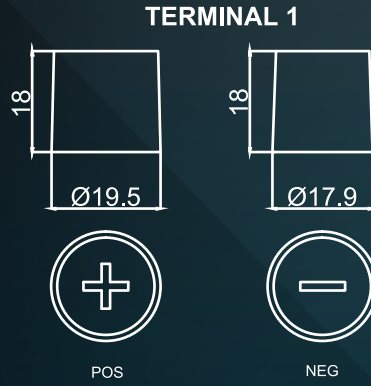

## Layout Types

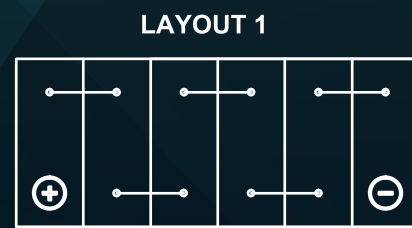
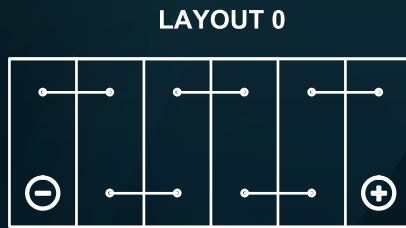

## Hold-down Types

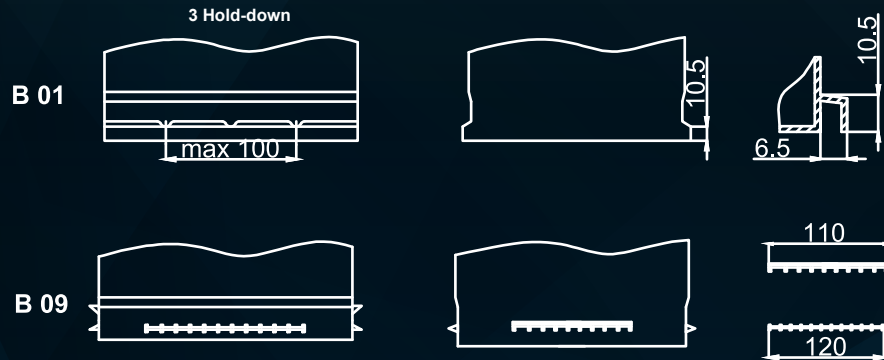

## Product Code Description

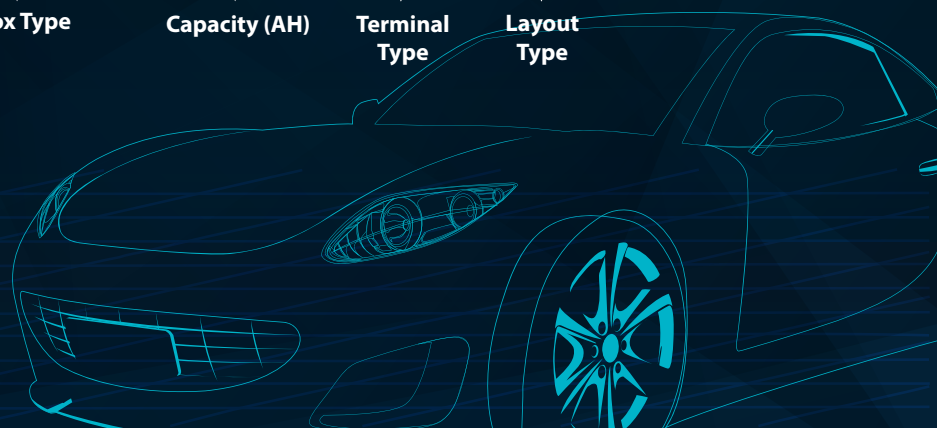
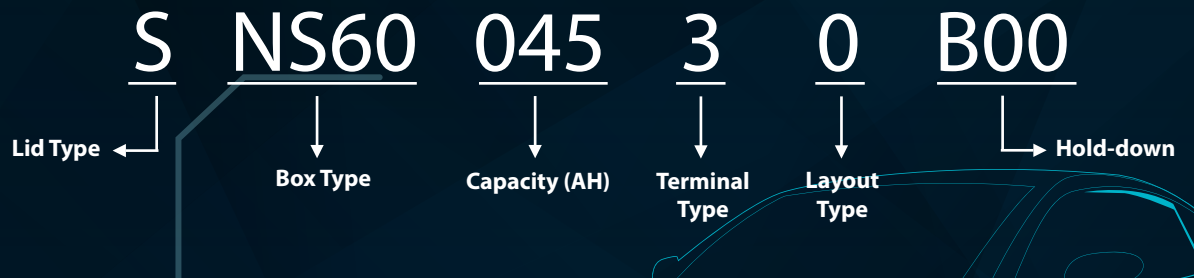

# ASIAN TYPE BATTERIES

Box Type	Product Number		Capacity Ah/20h	CCA		Terminal Type	Layout Type	Hold-down
	MF	SMF		EN	DIN			
NS40	NS40 035 30B00	S NS40 035 30B00	35	240	150	3	0/1	B00
	NS40 040 30B00	S NS40 040 30B00	40	270	170	3	0/1	B00
	NS40 042 30B00	S NS40 042 30B00	42	330	200	3	0/1	B00
NS60	NS60 045 30B00	S NS60 045 30B00	45	360	220	3	0/1	B00
	NS60 045 10B00	S NS60 045 10B00	45	360	220	1	0/1	B00

## AREAS OF USAGE

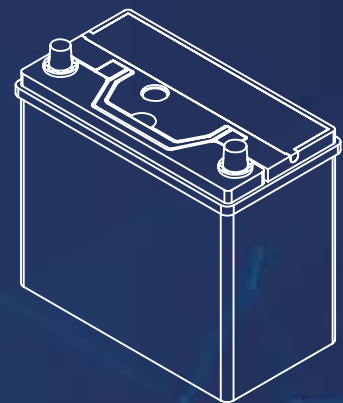
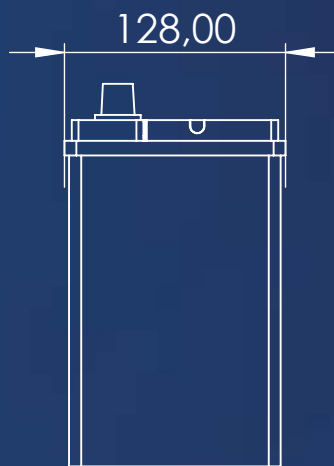
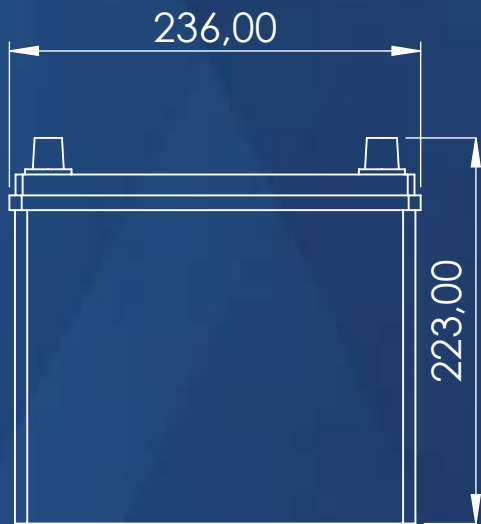
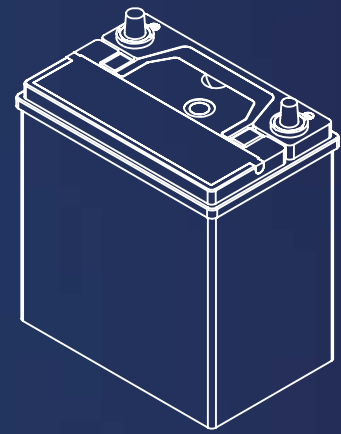
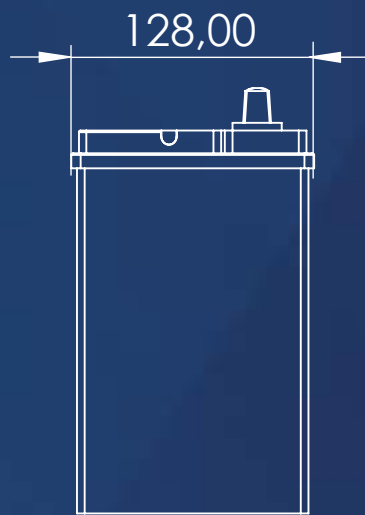
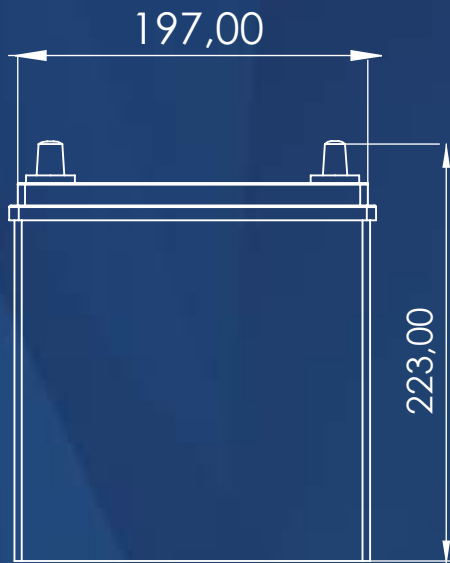

# ASIAN TYPE BATTERIES

Box Type	Product Number		Capacity Ah/20h	CCA		Terminal Type	Layout Type	Hold-down
	MF	SMF		EN	DIN			
D23	D23 055 10B09	S D23 055 10B09	55	460	240	1	0/1	B09
	D23 060 10B09	S D23 060 10B09	60	540	255	1	0/1	B09
N50	N50 070 10B09	S N50 070 10B09	70	600	340	1	0/1	B09
N70	N70 090 10B01	S N70 090 10B01	90	720	370	1	0/1	B01
	N70 100 10B01	S N70 100 10B01	100	800	480	1	0/1	B01

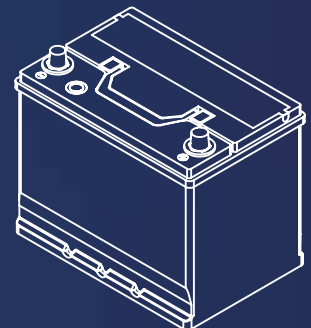
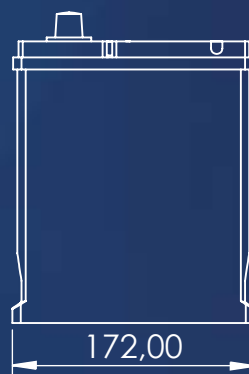
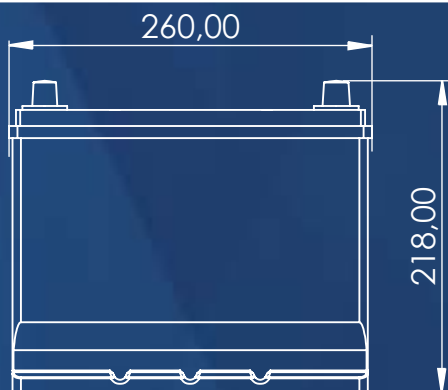
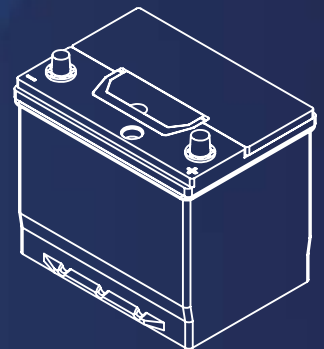
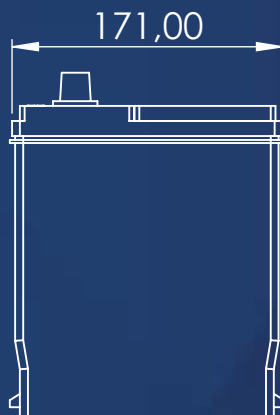
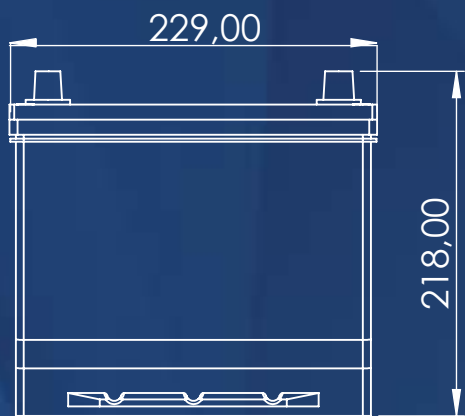

**SMF**

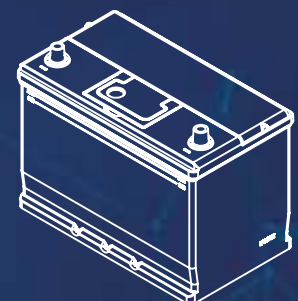
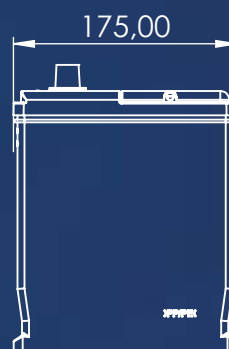

# START-STOP

## EFB



2 times more starting power and cycle life than standart batteries



10% fuel savings



10% less carbon emissions



Maintenance free SMF technology



High performance in harsh climatic conditions



# START-STOP

## AGM

3 times longer lasting performance than standart batteries



For vehicles with start-stop feature



For vehicles with high electrical equipment



Eco friendly with %20 less energy consumption



**START**  
**STOP**



# EFB BATTERIES

Box Type	Product Number	Capacity Ah/20h	CCA		Terminal Type	Layout Type	Hold-down
			EN	DIN			
L2	S L2 063 10B13	63	600	360	1	0/1	B13
L3	S L3 072 10B13	72	720	430	1	0/1	B13
L4	S L4 084 10B13	84	800	480	1	0/1	B13
L5	S L5 100 10B13	100	850	500	1	0/1	B13
N50	S N50 072 10B09	72	760	440	1	0/1	B09
C	S C 225 13B00	225	1250	700	1	3/4	B00

# AREAS OF USAGE

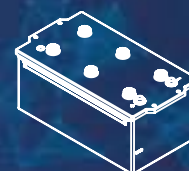
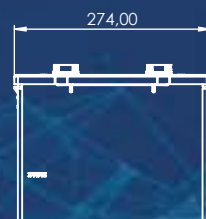
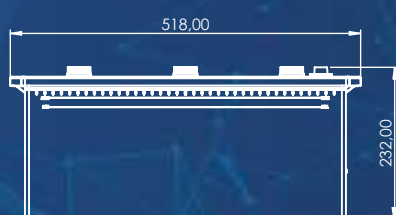
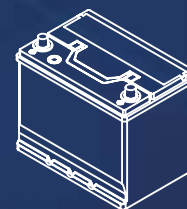
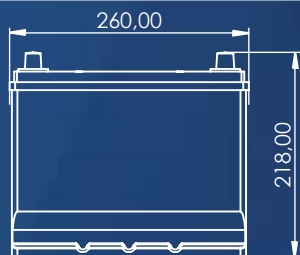
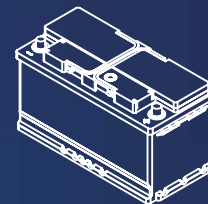
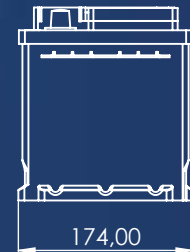
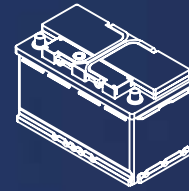
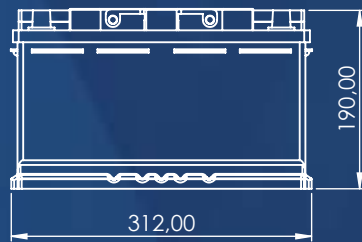
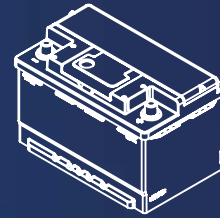
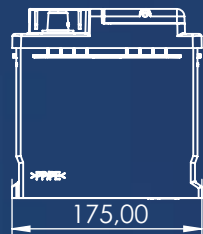
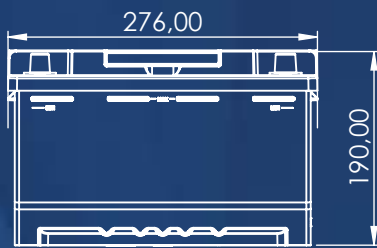
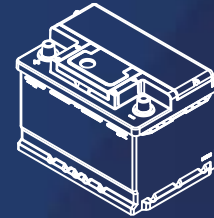
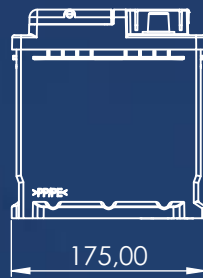
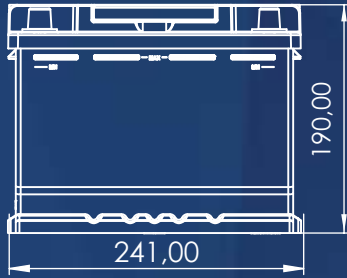

# AGM BATTERIES

Box Type	Product Number	Capacity Ah/20h	CCA EN	Terminal Type	Layout Type	Hold-down
L3	L3 070 10B13	70	760	1	0	B13
L4	L4 080 10B13	80	800	1	0	B13
L5	L5 095 10B13	95	850	1	0	B13



# AREAS OF USAGE

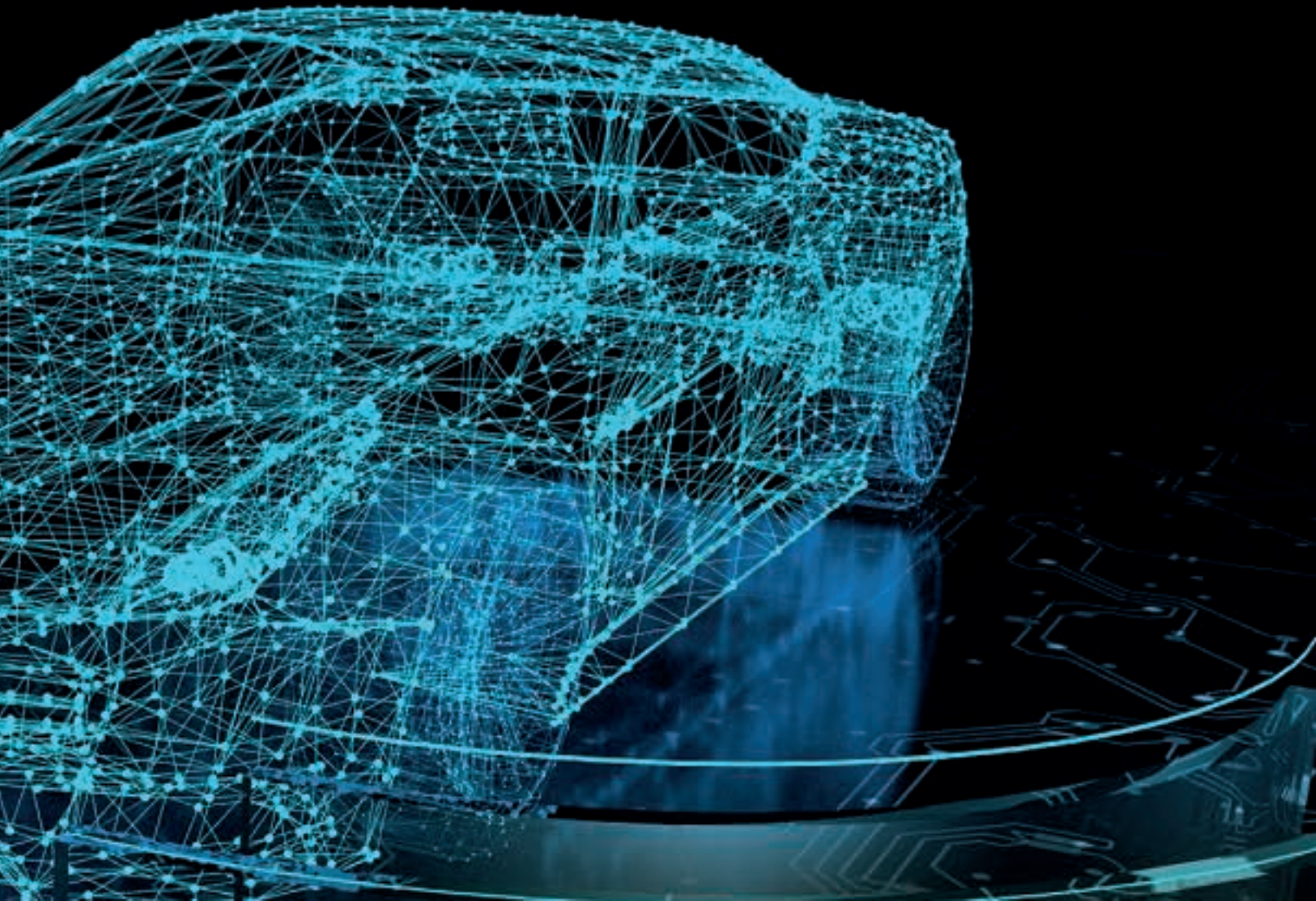
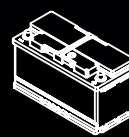
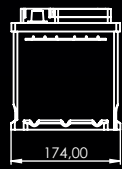
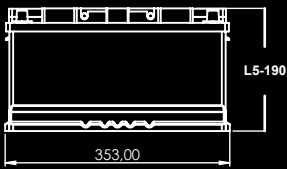
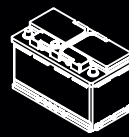
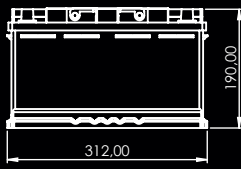
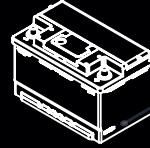
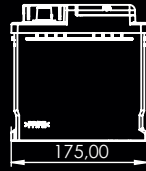
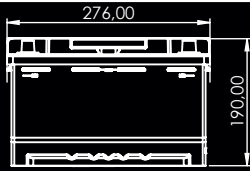

# HEAVY DUTY BATTERIES



High cranking and  
cycle capacity



Special internal structure and  
high performance



High corrosion resistance  
and low water loss



High cycle and  
vibration performance



## Lid Types

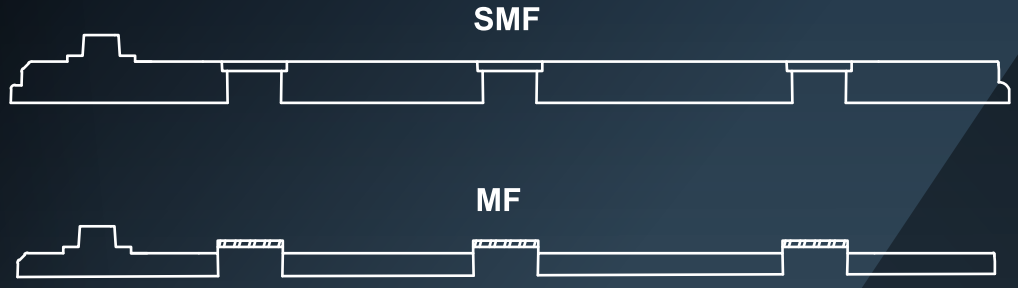

## Terminal Types

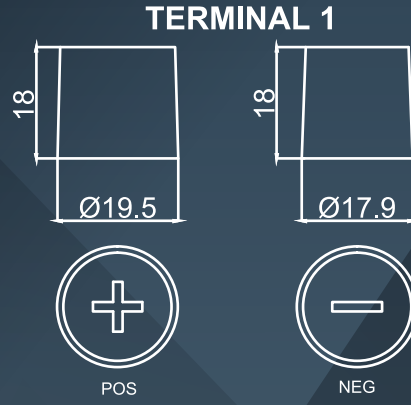

## Layout Types



## Hold-down Types



## Product Code Description

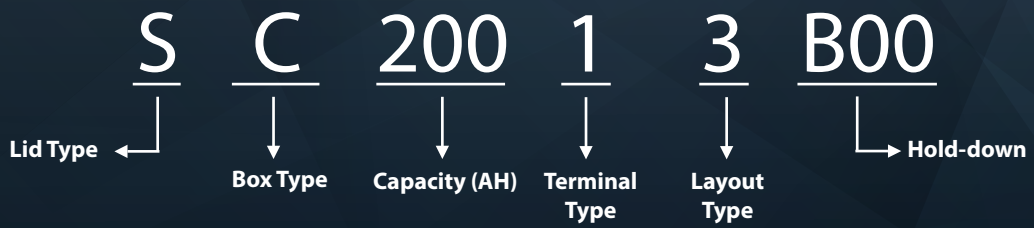

# HEAVY DUTY BATTERIES

Box Type	Product Number		Capacity Ah/20h	CCA		Terminal Type	Layout Type	Hold-down
	MF	SMF		EN	DIN			
A	A 120 13B03	S A 120 13B03	120	850	420	1	3/4	B03
	A 135 13B03	S A 135 13B03	135	950	450	1	3/4	B03
B	B 150 13B00	S B 150 13B00	150	1000	500	1	3/4	B00
	B 165 13B00	S B 165 13B00	165	1100	550	1	3/4	B00
	B 180 13B00	S B 180 13B00	180	1150	600	1	3/4	B00
	B 190 13B00	S B 190 13B00	190	1180	620	1	3/4	B00
C	C 200 13B00	S C 200 13B00	200	1200	630	1	3/4	B00
	C 210 13B00	S C 210 13B00	210	1220	650	1	3/4	B00
	C 225 13B00	S C 225 13B00	225	1250	700	1	3/4	B00
	C 240 13B00	S C 240 13B00	240	1400	750	1	3/4	B00

## AREAS OF USAGE

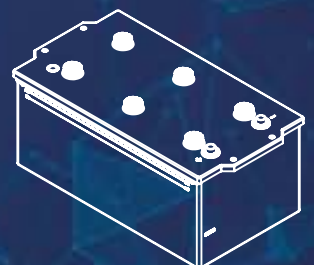
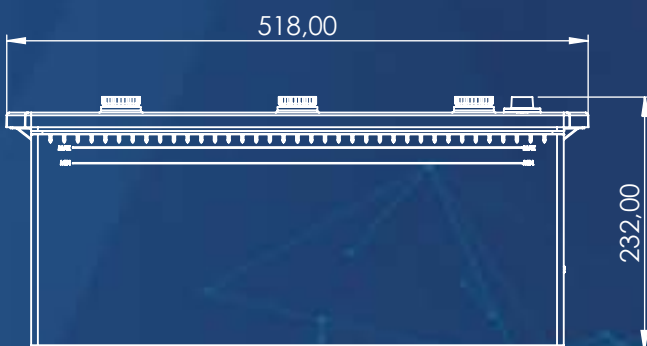
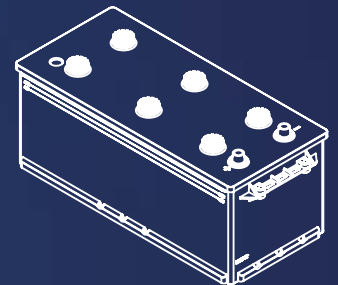
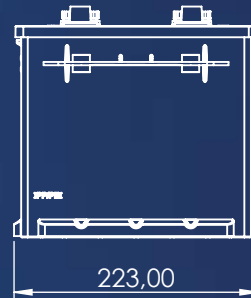
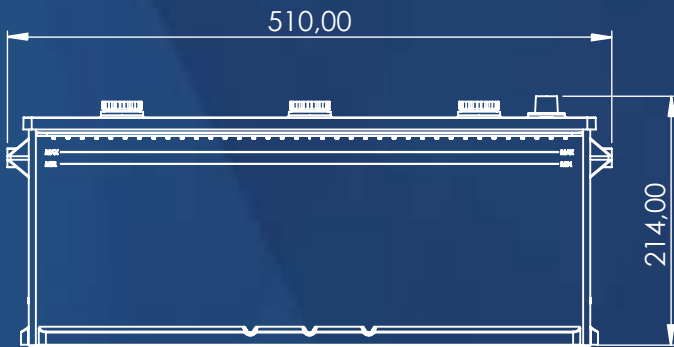
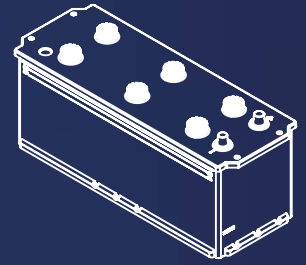
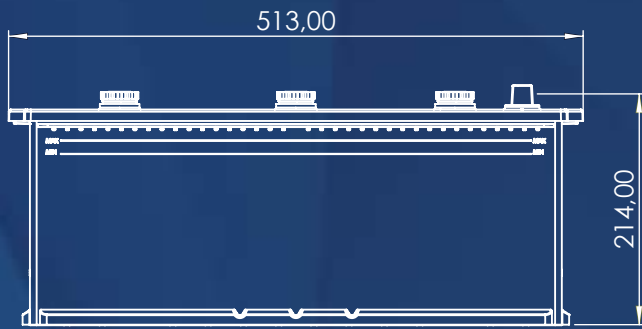

# Marine

# PREMIUM



Motor Yacht



Caravan



Generator

The **WORLD**  
Gets  
its **Power**  
from **US!**



# Marine

# PREMIUM

Marine batteries developed by Esan Battery for marine applications are designed according to the energy needs and usage conditions of vehicles operating in these areas and are produced with fully enclosed technology. Manufactured with maintenance-free fully closed technology and central gas outlet system, providing high safety and impermeability as well as flame arrester feature. Enhanced alloyed maintenance free batteries that are resistant to vibration and heavy use conditions, with their fastening systems in addition to the improved alloy grid, active material, internal structure elements and fiber separators developed by EsanBattery. Cycle life is longer than standard batteries, maximum shelf life is provided with minimum standby losses. These batteries are suitable for seasonal waiting.



**Maximum performance with starting power lifetime**



**Maximum resistance against corrosion**



**Fiber separators preventing rapid discharge**



**Maximum charge - discharge cycle**



**Extra resistance to vibration**

# Marine

# PREMIUM

## AREAS OF USAGE



Box Type	Product Number	Capacity Ah/20h	CCA		Terminal Type	Layout Type	Hold-down	Product Description
			EN	DIN				
L2	S L2 062 10B13	62	550	290	1	0	B13	Starter
N50	S N50 085 10B09	85	620	340	1	0	B09	Starter
GR31	GR31 11589B00	115	800	480	8	9	B00	Starter
A	S A 145 13B03	145	950	550	1	3	B03	Starter
B	S B 185 13B03	185	1150	600	1	3	B03	Starter
C	S C 230 13B00	230	1250	700	1	3	B00	Starter
A	S A 140 13B03	140	900	500	1	3	B03	Deep Cycle
B	S B 180 13B03	180	1100	550	1	3	B03	Deep Cycle
C	S C 225 13B00	225	1200	630	1	3	B00	Deep Cycle

## GR31

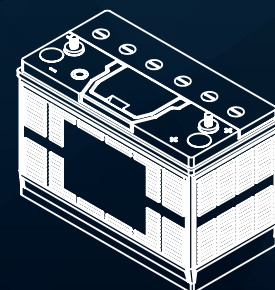
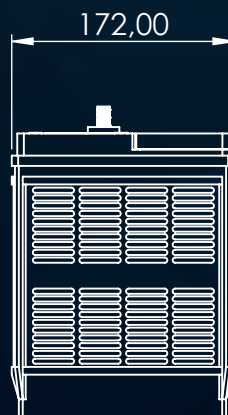
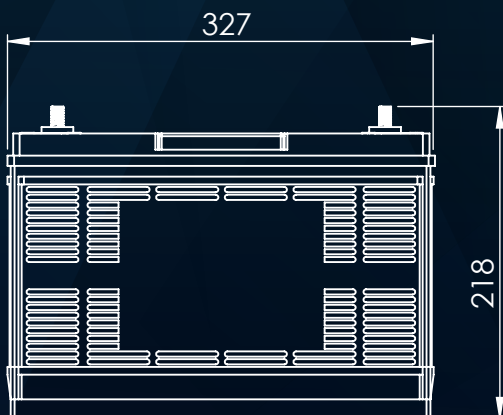

# PALLET CHART

EUROPEAN BATTERIES		
TYPE	EURO PALLET 80x120 cm	STANDARD PALLET 110x130 cm
LB1 - L1	88	144
LB2 - L2	76	120
LB3 - L3	64	100
LB4 - L4	56	96
LB5 - L5	48	63
H4	36	63

ASIAN BATTERIES		
TYPE	EURO PALLET 80x120 cm	STANDARD PALLET 110x130 cm
NS40	108	150
NS60	90	135
D23	80	93
N50	64	112
N70	42	84

HEAVY DUTY BATTERIES		
TYPE	EURO PALLET 80x120 cm	STANDARD PALLET 110x130 cm
A	24	36
B - D5	21	30
C - D6	18	24



Positive Energy

# The WORLD Gets it's Power from US!

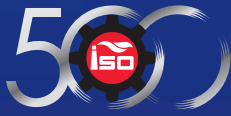

TURKEY'S  
SECOND TOP 500 INDUSTRIAL  
ENTERPRISES  
2020



🏠 Dilovası OSB 4. Kısım D 4011 Sok. No: 7 Gebze 41455 Kocaeli - Türkiye

☎ +90 262 502 17 40

☎ +90 850 227 37 26

📠 +90 262 502 17 38

📠 +90 533 453 25 57

✉ esan@esanaku.com

